

## ***Electric Central Heating Flow Boiler***

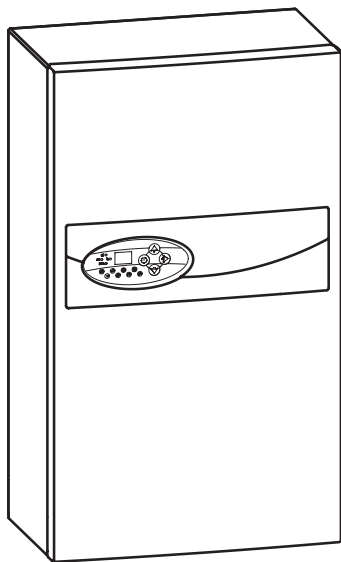

**EKCO.LN2M**  
**EKCO.L2M**



*This appliance is not intended for use by persons (including children) with reduced physical, sensory or mental capabilities or lack of experience and knowledge, unless they have been given supervision or instruction concerning use of the appliance by a person responsible for their safety. Children should be supervised to ensure that they do not play with the appliance.*



Used product can't be treated as general communal waste. Disassembled appliance has to be delivered to the collection point of electrical and electronic equipment for recycling. Appropriate utilisation of used product prevents potential negative environmental influences that may occur as a result of inappropriate handling of waste.

In order to get more detailed information about recycling this product you should contact the local government unit, waste management service or the shop where this product has been purchased.

1. Read and strictly follow the installation and operating instructions to ensure a long life and reliable boiler operation.
2. An efficient electrical installation which has been completed in accordance with the binding norms of electric installation.
3. A wet central heating system equipped with appropriate expansion vessel made according to binding norms of hydraulic installation- closed system.
4. A wet central heating system must be flushed before boiler installation.
5. Do not install any barrier fittings (e.g. valves) on the outlet of the safety valve.
6. Boiler must be installed on an even wall surface.
7. Boiler must not be installed in a humid place, in a place exposed to the danger of explosion or in a place where the ambient temperature may drop below 0°C.
8. Boiler installation and all electrical and hydraulic work must be performed by a qualified professional installer.
9. All installation work must be performed when the power and water supply is turned off.
10. Electric installation should be equipped with residual current protective devices and other solutions which will ensure disconnecting the heater from the source of power (intervals between all their poles should not be less than 3 mm).
11. Boiler is pre-set by the manufacturer to work with the central heating system. Change the factory settings in the advanced settings to shift to boiler's co-operation with DHW Cylinder.
12. Do not drain the water from central heating system after the heating season.
13. Leave the controller in stand-by mode and do not cut off power supply between the heating seasons.
14. If the boiler is intended for underfloor heating it is necessary to:
  - install safety fitting that protects against exceeding current flow temperature,
  - adjust suitable maximum flow temperature for given CH installation (advanced settings).

## Installation

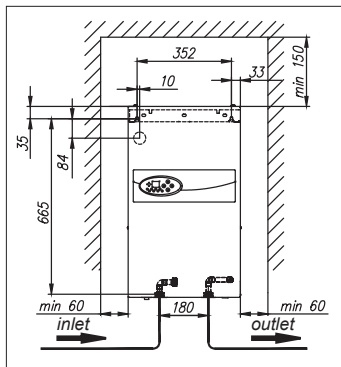

1. Hang the boiler up in a vertical position on fixing screws with the inlet and outlet pipes to the bottom, maintaining clearances from the walls and the ceiling.
2. Connect the boiler to the central heating system equipped with a cut-off valves.
3. Fill the central heating system with treated water or liquid nonfreezing.
4. Vent the central heating system.
5. Connect a boiler to the electrical system.
6. Mount the room thermostat in accordance with device's manual.
7. Connect the room thermostat (by using two wires  $2 \times 0,35 \text{ mm}^2$ ) to the terminal of control panel (RT entry).
8. Once you have finished the above procedures, you can start the boiler. See the „Start-up” section.

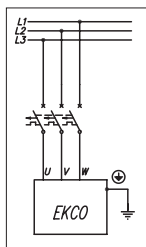

**!** While mounting thermostat make sure there is no voltage on its entry!

**Do not connect any voltage into RT, NA, Thw, Text entries!  
This can result in permanent controller damage.**

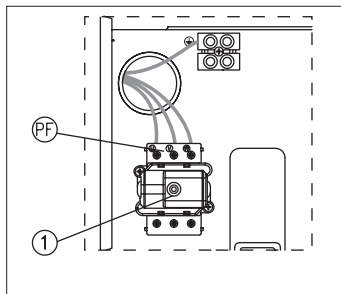

Connection to the three-phase electrical system. 230V 3~

PF - points of phase conductors connection

[1] - temperature limiter

EKCO.LN2M boilers are equipped with an expansion vessel (capacity: 6l, pressure: 1,5 bar). The expansion vessel is sufficient for following capacities of the heating system at given temperatures of the medium and central heating system pressure.

Temperature of heating medium (feed and return)	Capacity of central heating system	Pressure in central heating system
[°C]	[l]	[bar]
85/70	58	1,5
70/55	79	
55/45	103	
50/40	115	
45/35	128	

Shall the capacity of the wet central heating installation be larger, an extra expansion vessel should be installed on it.

## Boiler connection to the central heating system

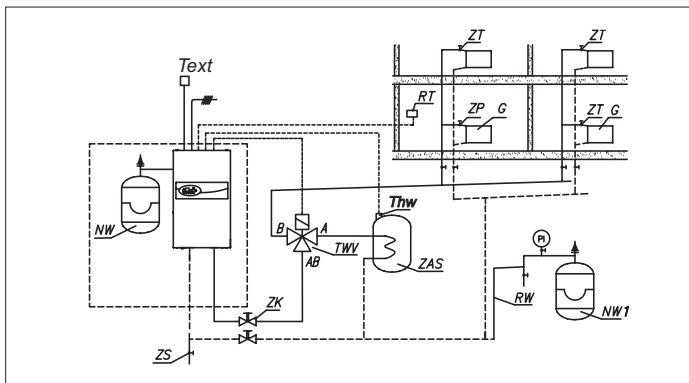

- PI - manometer
- ZK - cut-off valve
- RW - expansion pipe
- NW - built-in expansion vessel (EKCO.LN2)
- NW 1 - expansion vessel
- ZT - thermostatic valve
- ZP - passage valve

- G - radiator
- RT - room temperature thermostat
- ZS - drain valve
- TWV - three-way valve
- ZAS - DHW Cylinder
- Thw - WE-019/01 sensor
- Text - WE-027 sensor

## Connection of external appliances

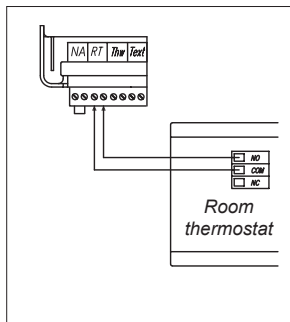

- TWV* - connection point of three-way valve  
*Thw* - connection point of water temp. sensor (in cylinder)  
*NA* - master appliance connection point (factory shorted)  
*RT* - room thermostat connection point  
*C* - master appliance  
*D* - room thermostat  
*E* - KOSPEL WE-027 outside temp. sensor  
*F* - KOSPEL WE-019/01 cylinder's water temp. sensor

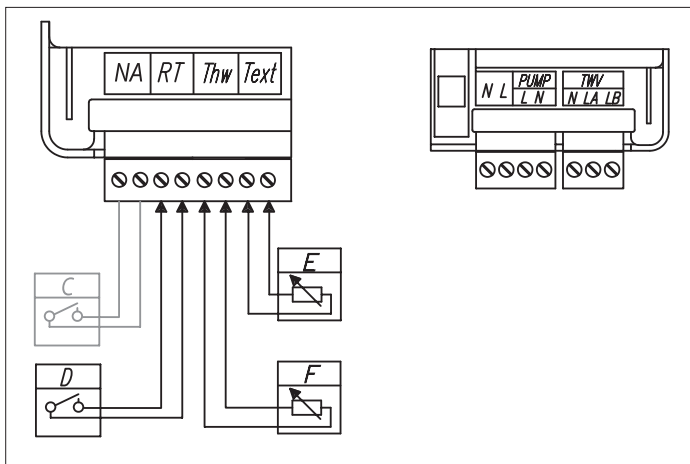

**Room thermostat (RP entry)** – when the voltage free contact gets opened the boiler will stop heating. The entry is responsible for boiler 's control depending on the room temperature (room thermostat connection details – section 'Installation', sub clause 7).





**Master appliance (NA entry)** – you can limit the power used, i.e. the boiler can be switched off while another appliance consumes electricity. To do it, an electrician should install in line an extra open contact to the NA entry (voltage free entry), so that when a master appliance gets on, the contact will be opened the boiler switched off. When the NA contact gets opened, heating will get off and the pump stopped. The EKCO.LN2 and EKCO.L2 model may also work as second boiler. If it is so, the master boiler by opening the NA entry will stop heating of EKCO. However, the mode of the three-way valve control stays on so a DHW cylinder is charged by the heat from the different heat source.

**WE-019/01 cylinder water temperature sensor (Thw entry)** - for connection details please, refer to the figure. If there is need to extend the wire- it is necessary to make it as short as possible. If the wire is too long there may occur disturbances and it may not work properly. The wires should not run close to mains cables and they must not go around other electric wires.



Note! To activate sensor and DHW cylinder heating function, please follow the instructions in section „Advanced settings”.



**Three way divert valve (TWV entry)** - the valve has to be connected in accordance with the diagram on page 18-19 depending on the model. Note: in order to activate DHW function one must follow the instructions in the section 'Advanced settings'.

**WE-027 outside temperature sensor (Text entry)**- for connection details please, refer to the figure. If there is need to extend the wire- it is necessary to make it as short as possible. If the wire is too long there may occur disturbances and it may not work properly. The wires should not run close to mains cables and they must not go around other electric wires. It is recommended to mount the sensor on the northern or north-west facade of the building away from windows and exhaust fans.

1. Check if required pressure has been reached within the installation (see section "Technical Data"). In order to check it use  or  button when control panel is „on”.  
Flashing A symbol (see section "Failures") indicates too low installation pressure. Above description does not apply to open type installations.
2. Set the pump at constant mode (see section "Advanced settings").
3. Switch the boiler on (press  button).
4. Check if the appropriate medium flow rate has been reached (the „H” indicator is on with a constant light). The pump should get vented itself after a short working time, however, if necessary, vent the pump in the following way:
  - close the cut-off valve on the outlet,
  - set the pump on the highest efficiency (see section "Advanced settings"),
  - let the boiler with the pump on run for 15-30 s.
  - open the cut off valve.
5. Switch the boiler off (press and hold  button for 3 seconds).
6. Set the pump at automatic mode (see section "Advanced settings").
7. Connect programmed room thermostat.
8. Switch the boiler on (press  button).
9. Set parameters of heating curve adjusted to the building (heating curve coefficient and offset) - see section "Advanced settings".  
Reset of the curve slope switches off weather compensation and starts boiler's operation in accordance with manual adjustments of the installation.



For advanced settings switch the control panel to stand-by mode (press and hold button  for approximately 3 seconds) then press and hold button , and for a short period of time press  and let go.

To select parameter press  to change the value press  or .

- boiler power - enter rated power (kW) as indicated on identification label,
- pump's working mode:
  - PA- automatic,
  - PC- constant.
- pump's efficiency [E]:
  - E3.0 - 3.0m,
  - E4.0 - 4.0m,
  - E5.0 - 5.0m,
  - E5.0 - 5.0m,
  - E7.0 - 7.0m,
  - E7.5 - 7,5m.
- pompe press mode [PPn]:
  - constant pressure difference (pressure indicator- on),
  - variable pressure difference (pressure indicator- flushing).
- number of active heaters [AH].
- DHW cylinder function [DHW function start up]:
  - 0- off,
  - 1- on,
- maximal temperature of CH installation,
- heating curve coefficient, weather compensation switch off:
  - C = 4 - 25,
  - C = 0 - weather compensation switched off, manual regulation of installation's temperature.
- heating curve offset:
  - o = -9°C ÷ 9°C.

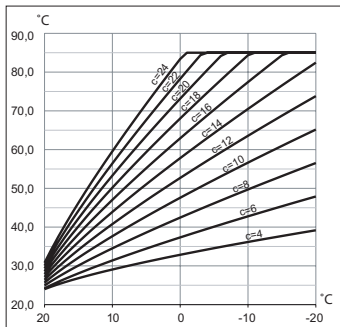

Heating curve coefficient.

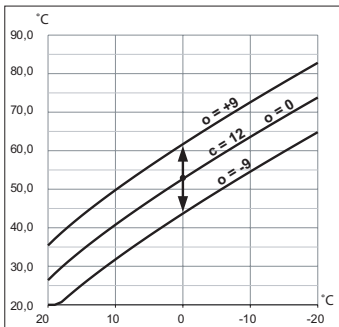

Offset of the heating curve for  $c=12$

- outside temperature of CH switch off: setting outside temperature above which CH circuit is switched off,
- pressure sensor in CH installation,
  - active (1),
  - inactive (0), sensor should be deactivated in open type installations,
- work time counter of boiler (read-only). Counter displays digits (without preceding zeros) from the most significant one with 0,5 sec breaks- after the display of the least significant digit, display is blanked for 2 sec.

To exit advanced settings and save all changes press and hold button .

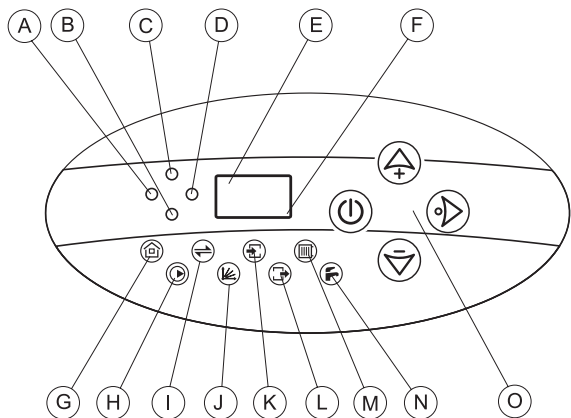



- A - pressure [bar]
- B - flow [l/min]
- C - power [kW]
- D - temperature [°C]
- E - digital display
- F - indicator of medium temperature setting (for DHW cylinder)
- G - indicator of room thermostat and heating activity (for central heating)

- H - indicator of pump and flow activity
- I - indicator of data transmission
- J - indicator of weather compensation controller
- K - inlet temperature indicator
- L - outlet temperature indicator
- M - indicator of boiler activity (CH)
- N - indicator of boiler activity (DHW)
- O - control buttons

## Stand-by mode

In the stand-by mode the pump is activated everyday for 2 min, which prevents its blockage. Control panel is blanked- only F indicator flashes. To switch stand-by mode press and hold for 3 sec  button.



**Note!** Do not cut off power supply in-between heating seasons. Pressing  or  buttons displays parameter of installation's pressure. After 1 min of inactivity the display becomes blanked again. Pressing  button in the stand-by mode shifts boiler's operation to winter or summer mode depending on the valid settings adjusted before activation of stand-by mode.

## Winter mode (CH)

Winter mode is activated when icon  is on.

In winter mode control panel displays pictograms that describe current boiler's operation mode- digital display indicates heating medium's temperature.

Pressing  button shifts to preview of current parameters and settings of boiler's operation in the following order:

- CH medium temperature adjustment (indicators D and M on), indicator J is on when weather compensation regulator is active (advanced settings). Indicator J flashes when there is no possibility to determine installation's temperature due to the lack or failure of outside sensor- the boiler shifts to manual adjustments. Pressing  or  buttons when heating medium temperature is indicated on the display results in heating medium value change. Note, it works only when weather compensation regulator is switched off (advanced settings - parameter C=0) or when there is no outside sensor,
- inlet temperature (indicators D and K on),
- outlet temperature (indicators D and L on),
- outside temperature (indicators D and G on),
- flow of the medium through the boiler (indicator B on),
- pressure in CH installation (indicator A on),
- activated power (indicator C on).



If the buttons are not used for 1 minute the display returns to general view mode.

Pressing  button during preview or adjustment of parameters results in immediate return to display's general view mode.





Optimal adjustment of heating medium temperature in accordance with outside temperature parameters and building's parameters results in low exploitation costs (reduced power consumption).

## Winter mode CH + DHW (winter mode option and co-operation with DHW cylinder)

In this mode the three-way valve directs the medium to either central heating installation or cylinder coil. The priority is to heat the DWH cylinder, at the same time the central heating system is off.

In CH + DHW icons  and  are on. In this mode control panel displays pictograms that describe current boiler's operation mode- digital display indicates heating medium's temperature.

Pressing  button shifts to preview of current parameters and settings of boiler's operation in the following order:



- CH medium temperature adjustment (indicators D and M on), indicator J is on when weather compensation regulator is active (advanced settings). Indicator J flashes when there is no possibility to determine installation's temperature due to the lack or failure of outside sensor- the boiler shifts to manual adjustments. Pressing  or  buttons when heating medium temperature is indicated on the display results in heating medium value change. Note, it works only when weather compensation regulator is switched off (advanced settings - parameter C=0) or when there is no outside sensor.
- preview and adjustment of water temperature in DHW cylinder (indicators D and N on). Water temperature in the cylinder is displayed only when WE-019/01 sensor is plugged to entry Thw. Pressing  or  buttons when water temperature in cylinder is indicated on the display results in temperature adjustment- regulation range: 30 - 80°C (indicators D, N, F on). Setting 0°C blocks boiler's heating on DHW cylinder which is indicated by flashing icon ,
- inlet temperature (indicators D and K on),
- outlet temperature (indicators D and L on),
- outside temperature (indicators D and G on),
- flow of the medium through the boiler ( indicator B on),
- pressure in CH installation (indicator A on),
- activated power (indicator C on).

If the buttons are not used for 1 minute the display returns to general view mode.



Pressing  button during preview or adjustment of parameters results in immediate return to display's general view mode.

Optimal adjustment of heating medium temperature in accordance with outside temperature parameters and building's parameters results in low exploitation costs (reduced power consumption).

### Summer mode (only with active cylinder's function)

To switch to summer mode press  (when in main view of winter mode). This mode is available only if the boiler co-operates with the DHW cylinder. Heating medium is directed to cylinder's coil. When icon  is on and icon  is off it shows that the boiler operates in summer mode. In this mode control panel displays pictograms that describe current boiler's operation mode- digital display indicates heating medium's temperature.

Pressing  button shifts to preview of current parameters and settings of boiler's operation in the following order:







- preview and adjustment of water temperature in DHW cylinder (indicators D and N on). Water temperature in the cylinder is displayed only when WE-019/01 sensor is plugged to entry Thw. Pressing  or  buttons when water temperature in cylinder is indicated on the display results in temperature adjustment- regulation range: 30 - 80°C (indicators D, N, F on). Setting 0°C blocks boiler's heating on DHW cylinder which is indicated by flashing icon .
- inlet temperature (indicators D and K on),
- outlet temperature (indicators D and L on),
- outside temperature (indicators D and G on),
- flow of the medium through the boiler ( indicator B on),
- pressure in CH installation (indicator A on),
- activated power (indicator C on).

If the buttons are not used for 1 minute the display returns to general view mode.

Pressing  button during preview or adjustment of parameters results in immediate return to display's general view mode.

Optimal adjustment of heating medium temperature in accordance with outside temperature parameters and building's parameters results in low exploitation costs (reduced power consumption).

## Icons and indicators

INDICATOR	STATUS	DETAILS
	ON	room thermostat allows the boiler to heat
	OFF	required temperature has been reached (boiler doesn't heat)
	flickering	master appliance doesn't allow to heat (NA entry is open)
	ON	pump is active, a proper flow rate of medium has been reached
	flickering	lack of flow or insufficient flow rate of medium (failure condition), a heating elements are off,
	red	heating on- boiler's CH mode
	green	desired temperature has been reached
		boiler co-operates with DHW cylinder (icon  in red) temp. in CH system is lower than required but the required room temperature has been reached, RT entry is open, or room thermostat is blocked
	OFF	summer mode on
	red	heating on - DHW mode
	green	heating on - DHW- required temp. of water reached
	flickering green	blockage of DHW heating
A	flickering	installation pressure is not sufficient (below 0,5 bar), heating is blocked, pump is inactive
E	horizontal dashes	parameter out of range or temp. sensor failure
K or L	flickering	relevant temperature sensor failure
	ON	preview of outside temperature

Symptom	Reason	Action
the indicators on control panel are off	lack of boiler power supply	check parameters of power network and fuses
		contact authorised service
A indicator flickers	insufficient pressure (below 0,5 bar)	shift the controller to the pressure view, increase pressure within the installation to required level
	pressure sensor failure	switch the controller to pressure preview, if display E indicates "--" contact authorised service
H indicator flickers	pump's blockage	unblock pump's rotor
	lack of medium's flow through the boiler- boiler's blockage	an air-bound central heating system, vent the installation, pump and boiler check patency of CH installation and clean the filter
	failure of pump's power supply	contact authorised service
	failure of pump or flow sensor	contact authorised service
G indicator is off (in winter mode), room thermostat indicates heating on	failure of installation that connects room thermostat	check connecting installation
	failure of electronic module	contact authorised service
K indicator flickers	failure of inlet temp. sensor, boiler shifted to failure condition	contact authorised service
L indicator flickers	failure of outlet temp. sensor, heating blockage	contact authorised service
G indicator flickers and the boiler doesn't work	failure of installation that connects master appliance	check connecting installation
	failure of electronic module	contact authorised service
EKCO.LN2 and EKCO.L2 model doesn't heat the cylinder	failure of cylinder's temp. sensor or thermostat	contact authorised service, replace temp. sensor or thermostat
	failure of three-way valve servo-motor	replace rotor
	failure of electronic module	contact authorised service
J indicator flickers	failure of external temp. sensor	contact authorized service
N indicator flickers (red)	failure of cylinder water temp. sensor	contact authorized service



## Technical data

Max. pressure		MPa	0,3 (3 bar)
Min. pressure		MPa	0,05 (0,5 bar)
Outlet temperature		°C	20 ÷ 85
Max. temperature		°C	100
Dimensions (height x width x depth)	EKCO.LN2M	mm	710 x 418 x 252
	EKCO.L2M		710 x 418 x 153
Wight	EKCO.LN2M	kg	~24,5
	EKCO.L2M		~17,2
Boiler's connections			G 3/4" (internal thread)
Expansion vessel	EKCO.LN2M	l	6
Safety class			IP 22

Rated power	kW	4	6	8	12	15
Rated voltage		230V 3~				
Rated current	A	3x10,0	3x15,0	3x20,1	3x30,1	3x37,6
Fuse rated current	A	16	20	25	40	50
Min. connecting wires section	mm <sup>2</sup>	4x1,5	4x2,5		4x4,0	4x6,0
Max. connecting wires section	mm <sup>2</sup>	4x16				

## AZV642 valve connection diagram

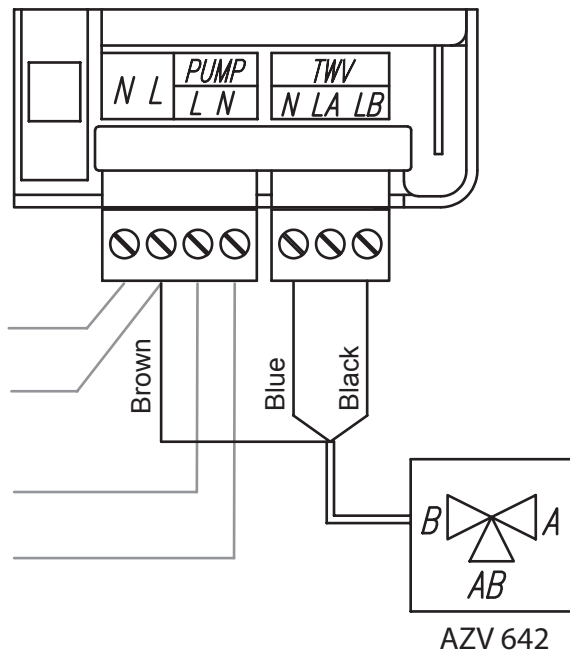

# Honeywell valve connection diagram

